

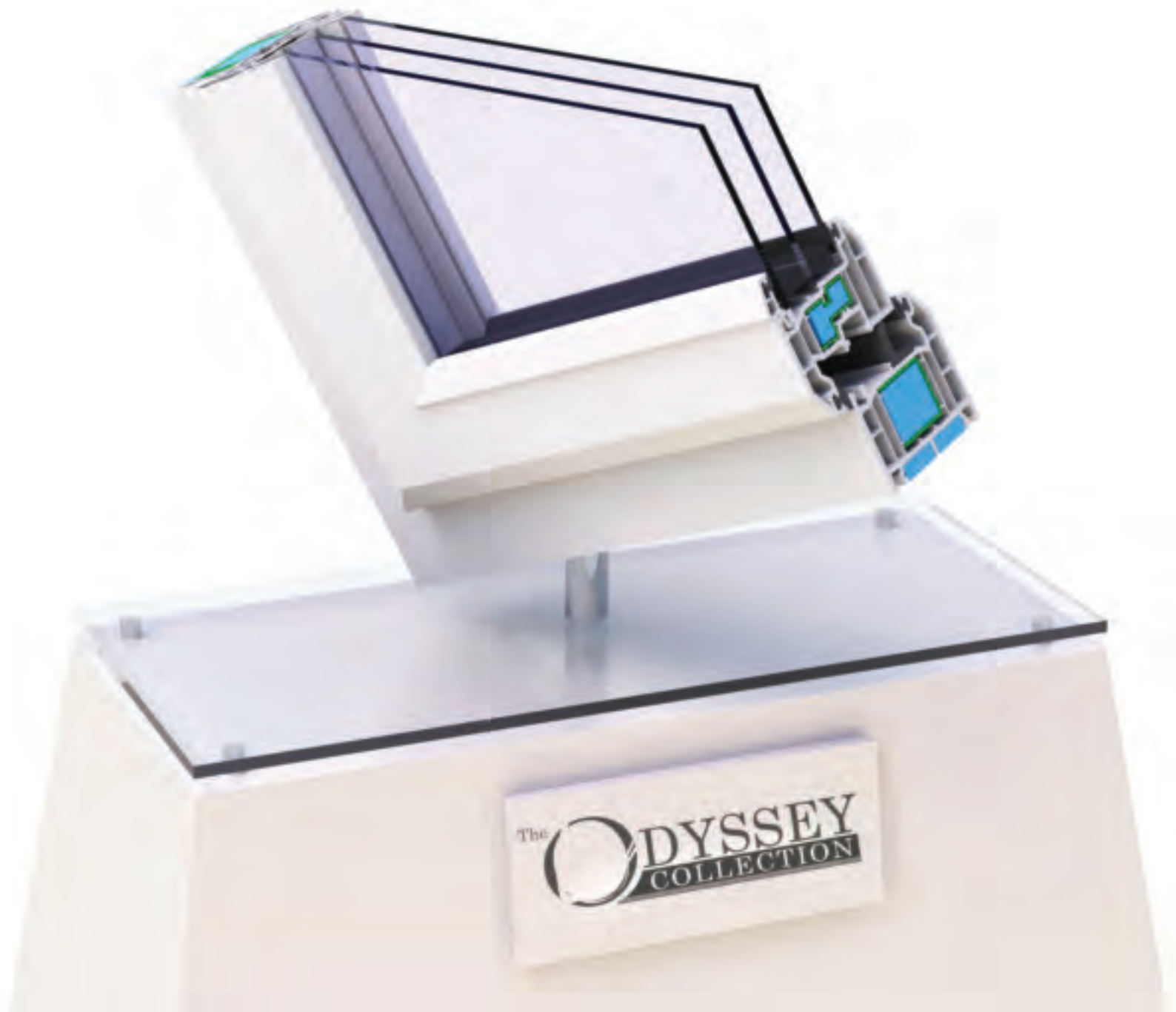

Sean Doyle Windows

The **ODYSSEY**
COLLECTION

Take the journey with us





Sean Doyle Windows have always prided themselves on quality, with excellent glass products and everything from hardwood, PVC, aluminium, vertical slides, shop fronts, curtain walling and conservatories, for both the commercial and residential sectors.

The company has always led the way in terms of quality and value for customers and the new energy efficient Odyssey C70 Collection will offer customers the opportunity to enter a different realm of energy saving.

Sean Doyle Windows have teamed up with Profine, the leading German PVC manufacturer.

Profine is a success story that runs for more than 100 years and places a strong emphasis on system thinking.

Quality from Profine means producing a range of products from research and development to production - from professional applications to ecologically-correct recycling.

Profile has amalgamated three of the biggest PVC brand names - from KBE, Kommerling and Trocal. These brands are the most accredited, highly regarded and respected brands globally in the PVC industry.

With a factory headquarters in Roscommon town and Dublin-based showrooms, Sean Doyle Windows is uniquely positioned to bring the C70 products to the Irish market. Five chambered and more energy-efficient systems are the future of the industry, replacing the old three-chambered technology of yesteryear.

The family-run business relies on an outstanding reputation for excellence, wide-ranging experience and a commitment to ensure our customers requirements are met.





Over 30 years of quality and success

With over 30 years of quality and success, Sean Doyle Windows is Ireland's leading specialist manufacturer of the finest traditional casement windows and doors.

Established in 1979 to produce high quality glass and glazing products, the company uses the most up-to-date technology with emphasis on attention to detail.

Choosing the right windows and doors for your home can be a tough decision to make. You need to consider style, security, performance and durability. You also want a product that will enhance the appearance and value of your property for years to come. We need to welcome the future of lead-free (green line)

that meets tomorrow's environmental standards - today .. and you will also be looking for sustainability - with a clear conscience.

The new C70 energy efficient system from Sean Doyle Windows is an innovative new product, which meets all the criteria in passive house building.

With over thirty years experience, Sean Doyle Windows is the first company to sell the C70 product on the Irish market.

The new Odyssey Collection features a unique five-chambered, engineered design which allows more cost-effective glass to be used in meeting the required energy ratings, thereby

allowing us to pass on the savings to our customers. With enhanced window energy ratings and low U values through new window and door systems, there are energy and cost savings for the homeowner. It is estimated that the average three bedroom detached house can save between 10-25% on their ESB and heating bills through these unique energy saving products.

*The Odyssey C70
Collection - it's time to
take the journey with us.*



Sean Doyle Windows headquarters.





Sean Doyle Windows

The **ODYSSEY**
COLLECTION
C70 WINDOWS



Sean Doyle Windows

We design our own products,
we manufacture our own products,
We install our own products

Design

Perfect proportions with slim window profiles, classic design with choice of colour the Odyssey C70 fulfils every wish.

Economic Efficiency

Whatever the requirement, Odyssey C70 always has a solution. 'Economic Efficiency' is always at the forefront.

Thermal Insulation

Odyssey C70 has a value of 1.3 in the standard version and top values of 0.8 for windows certified as suitable components for passive houses.

Sound Insulation

The ideal combination of three layers of the sash rebate seals and a wide spectrum of glazing, offer numerous sound insulation values up to 48 dB (Class 5).

Security

In burglary tests, Odyssey C70 window profiles together with corresponding fittings and burglary-proof glazing, achieved the resistance class 2.

Environmental protection
Reduction in energy consumption and CO₂ emissions, stabilisation with calcium-zinc instead of lead, use of recycled material, full recyclability - these standards are leading the way in environmental protection.



The Odyssey Collection C70 - 28

Imagine the possibilities

Over the past decade, Profine's groundbreaking exterior window and door technology has caused a worldwide revolution in the window and door industry.



Odyssey C70 windows have been designed to state-of-the-art standards.

Constantly rising energy costs demands maximum economy. An investment in window profiles with a high thermal insulation value is therefore an investment that pays off. Thanks to their consistent five chamber technology and receivers for a wider range of insulated functional glazing, the Odyssey C70 achieves top u/values that can afford a crucial contribution to energy cost savings.

Designed, manufactured and tested to the most stringent standards, the Odyssey C70 is everything you want and need in a window system for your home. Style, strength, security and one that is built to last.

- U, value 1.3 W/(m²K)
- Five chambered profile gives improved insulation and strength
- Totally lead-free calcium organic stabilised profile suite
- 100% recyclable
- Extra-ordinary thermal insulation

Whole window Energy index
9.58





Sean Doyle Windows

 The
ODYSSEY
 COLLECTION

The Odyssey Collection C70 - 28



The innovative sash rebate seal reduces thermal conductivity and air movement and ensures excellent thermal insulation values.



28mm double glazed argon-filled unit

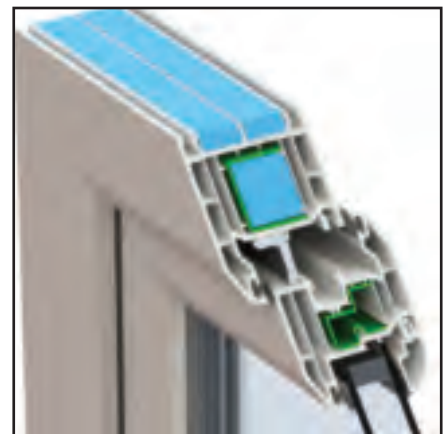

Sash and Rail chamber detail showing steel reinforcing and conductor seal.

Whole window
U/V value

1.3

W/m² K

- Multi-chamber construction provides excellent stability for best thermal and sound insulation
- 70 mm frame depth
- 5 chambered for better thermal performance
- Frame with screwed steel inlay and insulation with 70 mm construction depth
- High security multi point locking and shoot bolts
- Glass thickness of 20 mm to 36 mm
- Internal or external glazing





The Odyssey Collection C70 - 36

Proven durability

As much as Profine C70 enjoys its reputation for innovation, ensuring its products meet and exceed the highest standard of durability is just as much of a passion.



- U, value 1.0 W/(m²K)
- The Odyssey C70 windows help you to save heating costs and make your home more cozy
- Odyssey C70 includes many features and benefits that make it simply unbeatable
- Steel re-inforced profiles
- Multi-locking and shoot bolts, sealed unit double glazing, high impact bolts
- Enhanced thermal insulation with optimal thermal properties

The Odyssey C70 windows help you to save money on heating costs and make your home more cosy.

The innovative FIVE CHAMBER technology and the larger building depth of the Odyssey C70 contribute to greater thermal insulation.

Whole window Energy index
19.76

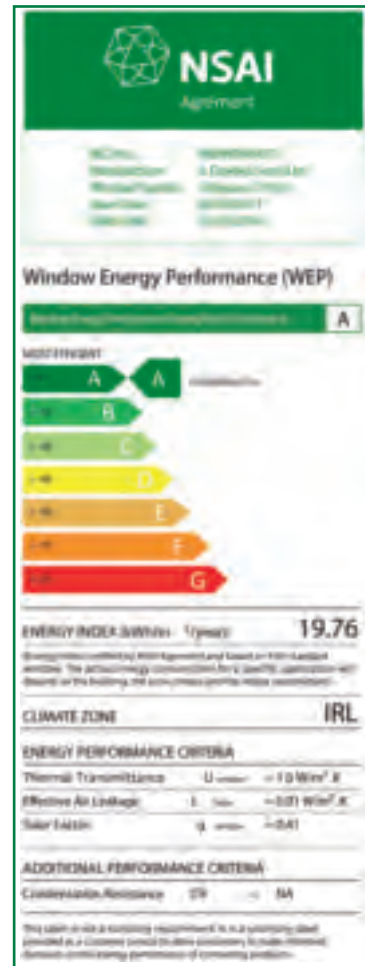



Sean Doyle Windows

 The
ODYSSEY
 COLLECTION

The Odyssey Collection C70 - 36



The innovative sash rebate seal reduces thermal conductivity and air movement and ensures excellent thermal insulation values.



36mm treble glazed argon-filled unit

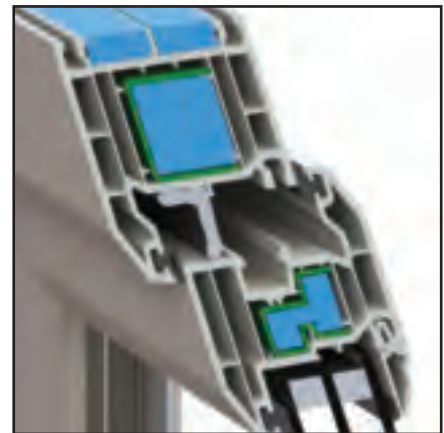

High density insulating foam

Whole window
U/V value

1.0

W/m² K

- Triple Glazed unit improved energy saving unit contains low emissivity glass and argon filled cavities with overall 36mm glass
- Warm edge technology much lower thermal conductivity than traditional spacers. Consequently the temperature at the edges of the glass is several degrees warmer
- Five chamber for a better thermal performance
- Glass from 28 - 44 mm
- All A-Rated as standard for all colours
- A fully reinforced



The Odyssey Collection C70 - 44

High performance system

Internal environment, operational function, durability, pain-staking attention to detail and a commitment to quality mean Odyssey C70 performance, whatever the category. The result is a degree of control and comfort for the end-user that matches the easy flexibility of modern design.



As much as the Odyssey C70 enjoys its reputation for innovation, ensuring products meet and exceed the highest standards for durability is just as much a passion

This means a significant investment in repeatedly testing systems under the toughest of conditions, then testing them again.

Whole window Energy index
31.40

Ireland's best energy rated window certified by the N.S.A.I

- U, value 0.8 W/(m²K)
- 70mm frame depth
- Five chambered for better thermal performance
- Steel reinforced profiles
- The innovative multi-chambered profile exhibits outstanding thermal properties and provides the space that is needed for high thermal insulation
- Chambered or ovolo glazing beads
- Wide range of colours
- High security multi-point locking and shoot bolts
- High impact, colourgast and lead free PVCu profiles that are better for the environment

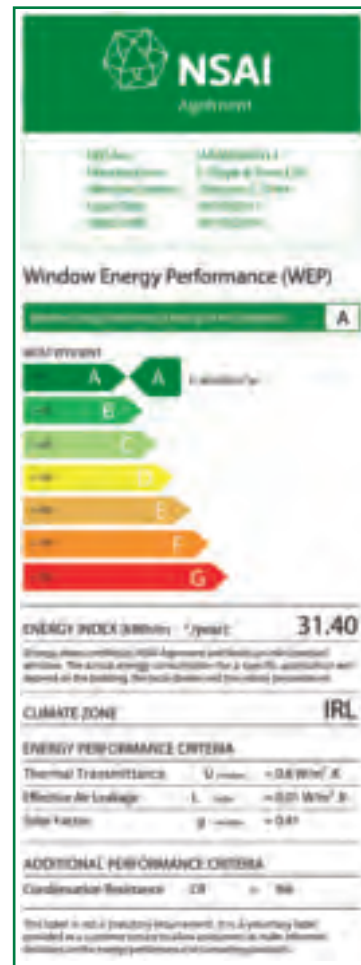



Sean Doyle Windows

 The
ODYSSEY
 COLLECTION

The Odyssey Collection C70 - 44

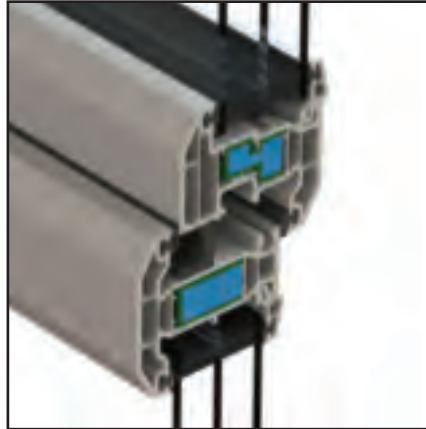

The innovative sash rebate seal reduces thermal conductivity and air movement and ensures excellent thermal insulation values.



44mm treble glazed argon-filled unit

Whole window
U/V value
0.8
W/m² K



High Density Insulation Foam

- The Odyssey C70 /44 has the highest energy index of any uPvc window on the Irish Market to date.
- Profile construction depth of 70 mm
- Thermal insulation and energy efficiency through high solar gains which makes the Odyssey C70 / 44 most suited to lowest energy and passive houses due to the innovative technology
- Triple gaskets on all sides for maximum impermeability
- German engineered proven design and high performance
- All claims independently verified
- Suitable for all applications up to 0.8 passives





Odyssey C70
Door Collection

New German Engineered
5 Chambered PVC Door





There is something reassuring about coming home to a front door that you love!

Our collection comprises of different styles derived from designs and configurations of entrance doors typically found in period homes across the country

The doors are available in a range of colour finishes

Each door is hung on robust, fully adjustable hinges that are colour coordinated to the handle and door threshold. Fitted with multi-point locking mechanisms to Association of British Insurers Approved standards, featuring hook bolts and deadlock.

The Odyssey door is of German engineering with internal corner blocks that ensures that all doors are welded internally as well as externally.

All doors are fully reinforced.

The Odyssey C70 door is the strongest PVC door on the Irish market today.









- **Enhanced Thermal Insulation**
- **Greater Sound Insulation**
- **Greater Safety**
- **Attractive Design**

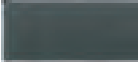

Thermal insulation - The thermal image shows the optimised distribution of isotherms

Colour palette

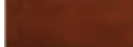
GREY	RAL 7015		BLACK	RAL 9005	
CREAM	RAL 1003		GOLDEN OAK		
GREEN	RAL 6005		OREGAN PINE		
RED	RAL 3003		WOODGRAIN		





Door Technology

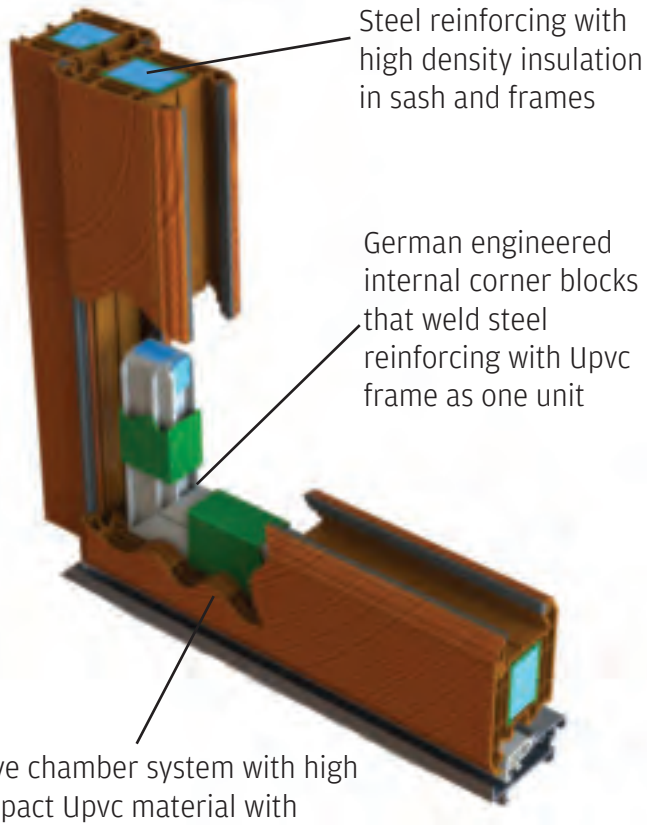

Five chamber system with high impact Upvc material with modern additive technology with colour fast and lead free pvc profiles which is better for the environment



Door Thresholds Details



Wheelchair Access Threshold

Distance from bottom of door leaf to bottom of threshold 20mm



uPVC Full Frame Threshold

Distance from bottom of door leaf to bottom of threshold ~43mm



uPVC Low Frame Threshold

Distance from bottom of door leaf to bottom of threshold 27mm





Odyssey C70 Doors Locking Technology

The Odyssey front doors have several unique features which include the incorporation of double rebated steel reinforced within the door leaf. This provides exceptional stability to the door leaf whilst simultaneously enhancing its security. In addition to this, the Odyssey door is fitted with a three point locking system with steel striking plates, security cylinders and steel hinges with anti-lift side bolts to give maximum security, as required for Secured by Design accreditation.

- Profile construction depth of 70 mm
- 5 chamber profile, thermally broken

with polyamide rails and foamed insulating core to prevent thermal bridges and ice

- Triple gasket construction
- Available upon request with multi-point lock for increased burglary protection
- Three dimensionally adjustable door hinges
- Glass and panels up to 44 mm
- Robust door sash through 5 chamber aluminium profiles
- As standard with lever handles on both sides - choose between key hole cover plate or narrow plate



Dog Bolts



Flat Brushed Chrome

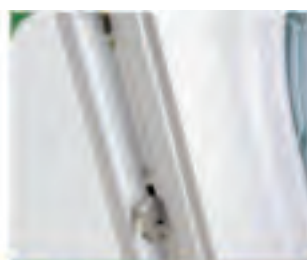

Hook Locks



uPVC Threshold

uPVC Threshold



Shoot Bolts (Top & Bottom)



Swept Black Chrome



Suited Handles



Aluminium Threshold

Aluminium Threshold



Lock Upgrade



Tube Gold



Lock

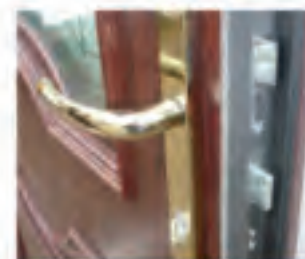

Lock



Roto Twin-Cam Security Lock (TSL)

Twin-cam Security Locking (TSL) from Roto is a major breakthrough in window locking systems, offering more than double the security of industry standard products and giving you a host of reassuring benefits:

- Innovative design makes TSL one of the strongest and most reliable locking systems on the market.
- High quality materials and finishes give TSL exceptional corrosion resistance, whilst rigorous production control methods ensures that each product will last for many years. TSL even carries a 10 year guarantee to give you added assurance.
- Secured by Design and BBA approval.
- Precision engineering gives TSL its smooth, effortless operation.
- With a simple turn of the handle, TSL's unique gearbox activates up to four pairs of high strength 'mushroom' cams. Each pair of cams closes together, utilising both sides of a security striker. This double action locking significantly enhances resistance to jemmying from all directions and strengthens the window's security.





LEFT TO RIGHT: Maurice Buckley, Chief Executive, NSAI; Kenneth Doyle, Sean Doyle Windows; Paul McCarthy, Profile systems and John Perry T.D., Minister of State for Small Business, pictured at the recent award ceremony where Sean Doyle Windows received full NSAI certification.

Certified and awarded many times over

National and international certifications confirm the high quality of our products. Our know-how assures that you will receive the best quality and value for your money as research and development are important. With

30 years of experience, our new Odyssey range underlines the pioneering leadership of our company. Latest production facilities and strictest quality control ensure consistent quality which sets standards throughout

Ireland. As proof for this Odyssey bears the NSAI logo, Ireland's leading label for windows, doors and insulation in new and refurbished homes throughout the country.







Sean Doyle Windows





Sean Doyle Windows

Circular Road, Roscommon, Co. Roscommon Telephone:
090 662 6753 • Email: sales@sdwindows.ie

Whitestown Business Park, Whitestown Industrial Estate,
Tallaght, Dublin 24 • Telephone: 01 462 6671
Email: sales@sdwindows.ie • www.seandoylewindows.ie

Follow and like:    Sean Doyle Windows

SCAN WITH YOUR PHONE AND
FOLLOW US ON INSTAGRAM



SEANDOYLE.WINDOWS

